

HELI

ENGINE POWERED 2-3t



Digital Instrument

- Clear and easy to read
- Instantaneous reading when switched on
- Ergonomical layout



Wide View Mast

- H2000 series forklift trucks are fitted with wide masts that give the operator greater visibility to the front



Superior Steering Axle

- Fully power assisted steering as standard which is compact and easy to maintain

h2000
SERIES

CPC20/25/30
CPCD20/25/30
CPQ20/25/30
CPQD20/25/30



STANDARD SPECIFICATION

Manufacturer				ANHUI HELI CO., L							
Model				CPQ20/CPQD20		CPQ25/CPQD25		CPQ30/CPQD30			
Load Capacity				kg	2000		2500		3000		
Load Center				mm	500						
Power Type				Gasoline							
Control Type				Sit Down Rider Type							
Tire Type		Front/Rear		Pneumatic							
Wheels(X=Driven)		Front/Rear		2x/2							
Maximum Fork Height				mm	3000						
Free Lift				mm	155				160		
Fork Size (LxWxT)				mm	920 x 122 x 40		1070 x 122 x 40		1070 x 125 x 45		
Tilt Angel		Fwd/Bwd		deg	6 / 12						
Length to Fork Face				mm	2482		2552		2675		
Overall Width				mm	1150				1225		
Mast Height Fork Lowered				mm	1995				2070		
Overhead Height Fork Raised				mm	4030				4250		
Overhead Guard Height				mm	2070				2090		
Turning Radius (Outside)				mm	2170		2240		2400		
Load Distance (Centerline of front axle to front face of forks)				mm	450				475		
Basic Right Angle Stacking Aisle Width(Add load length and clearance)				mm	2620		2690		2875		
Speeds		Travel Max. (Fwd/Rvs)		With Load	km/h	17.0				18.0	
				Without Load	km/h	19.0				19.5	
		Lifting		With Load	mm/s	570				450	
				Without Load	mm/s	600				500	
		Lowering		With Load	mm/s	450					
				Without Load	mm/s	550				500	
Max. Drawbar Pull		With/Without Load		kg	1250/850	1680/850	1250/850	1680/850	1100/1000	1350/1000	
Max. Gradeability		With/Without Load		%	20/20	20/20	17/18	22/18	15/20	18/20	
Total Weight				kg	3320		3680		4280		
Weight Distribution		With load		Front	kg	4730		5480		6455	
				Rear	kg	590		700		825	
		Without load		Front	kg	1520		1465		1720	
				Rear	kg	1800		2215		2560	
Tire Size		Front		7.00-12-12PR				28*9-15-12PR			
		Rear		6.00-9-10PR				6.50-10-10PR			
Wheel base				mm	1600				1700		
Tread		Front		mm	970				1000		
		Rear		mm	970						
Ground Clearance		At Lower Point(Mast)		mm	110				140		
		Frame		mm	115				140		
Brake		Service		Hydraulic-Foot Pedal							
		Parking		Mechanical-Hand Lever							
Battery		Voltage/Capacity		V/AH	12/60						
Internal Combustion Engine		Model		NISSAN H20 KA							
		Rate horse power		kW(Ps)/r.p.m	32.3(44)/2300						
		Rate torque		N.m(kg.m)/r.p.m	142(14.5)/1600						
		Number of Cylinder		4							
		Displacement		L	1.982						
Fuel Tank Capacity		L	60								
Transmission		Number of Speed Fwd/Rvs-Type		1-1 Power Shift T/M							
				2-2 Manual Shift T/M							
Operating Pressure		For Attachment		kg/cm ²	175						

LTD.

CPC20/CPCD20	CPC25/CPCD25	CPC30/CPCD30			
2000	2500	3000			
500					
Diesel					
Sit Down Rider Type					
Pneumatic					
2x/2					
3000					
155		160			
20x 122 x 40	1070x 122 x 40	1070 x 125 x 45			
6 / 12					
2480	2550	2675			
1150		1225			
1995		2070			
4030		4250			
2070		2090			
2170	2240	2400			
450		475			
2620	2690	2875			
17.0		18.0			
19.5		19.5			
550		450			
580		500			
450					
550		500			
0/850	1700/850	1300/850	1700/850	1200/1000	1500/1000
/20	27/20	18/18	23/18	15/20	18/20
3410		3770		4370	
4775		5525		6500	
635		745		870	
1560		1510		1760	
1850		2260		2610	
7.00-12-12PR			28*9-15-12PR		
6.00-9-10PR			6.50-10-10PR		
1600		1700			
970		1000			
970					
110		140			
115		140			
Hydraulic-Foot Pedal					
Mechanical-Hand Lever					
12/80					
ISUZU C240 PKJ					
34.5(47)/2500					
139(14.2)/1800					
4					
2.369					
60					
1-1 Power Shift T/M					
2-2 Manual Shift T/M					
175					

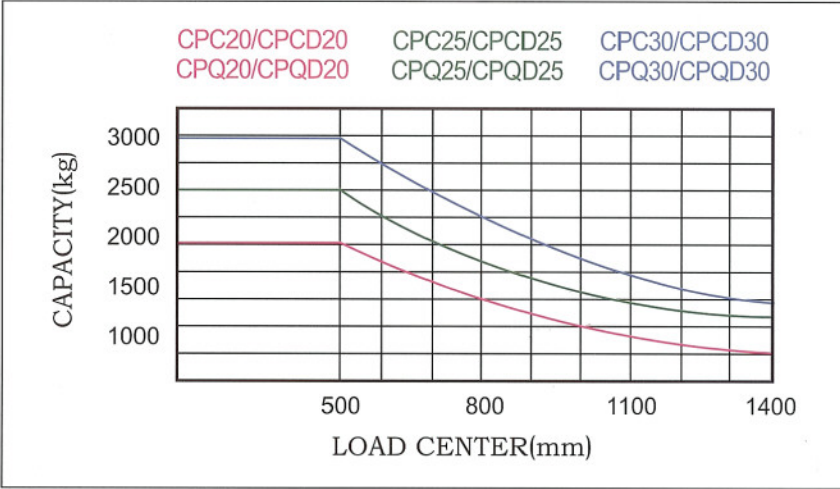

Note:
Capacities shown are computed with upright in vertical position. Load centers are determined for front face of forks. Capacities are based on a 1000 mm cube load configuration with the center of gravity at the true center of the cube, and standard forks. Truck capacities with upright in forward tilt position will be less. Long forks, and unusually wide or loads may also reduce capacity.

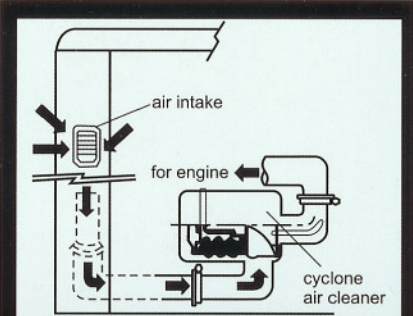

The large Intake Area of Air Intake System

The snorkel air intake is situated on one of the pillars for the overhead guard, which is far from the dust being created by the wheels. It breathes in the clean air and reduces the noise.



The sound-absorbed materials

- Heat-insulation/vibration absorbing
- Lowest noise
- Rubber sealing packing at the gap between engine hood and truck body.

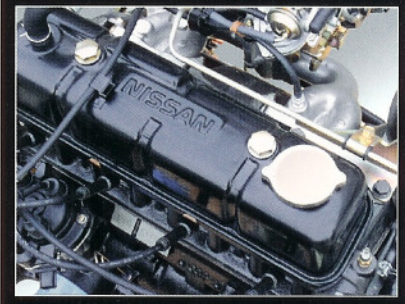
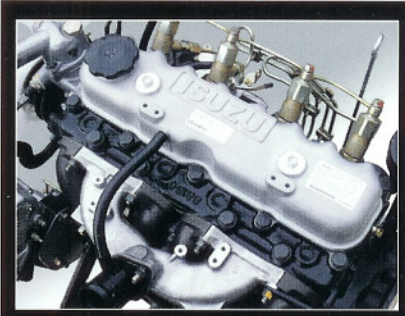

New Engine with Low Consumption STANDARD

- ISUZU C240PKJ diesel engine
Rated Power 47 ps/2500 r.p.m
Rated output 2369 cc
- NISSAN H20 gasoline engine
Rated Power 44 ps/2300 r.p.m
Rated output 1982 cc

Hi-POWER

- ISUZU 4JG2 Hi-power diesel engine
Rated Power 61 ps/2450 r.p.m
Rated output 3059 cc
- NISSAN H25 gasoline engine
Rated Power 56 ps/2500 r.p.m
Rated output 2472 cc

Specification of Optional High Power Engine

Engine	Type		NISSAN H25	ISUZU 4JG2
	Rated power	kw/r.p.m	41/2500	44.8/2450
	Rated torque	kg.m/r.p.m	18.3/1600	19/1600~1800
	Cylinder quantity		4	4
	Displacement	cm ³	2.472	3.059

STANDARD EQUIPMENT

- Wide view mast
- Class II (III) carriage
- Load backrest
- Standard fork
- J-Lug long life tires
- Power steering
- Retaining rollers
- Overhead guard
- Standard seat
- Drawbar pin
- Cyclopack air cleaner
- Toggle type parking brake lever
- Lift and tilt levers
- 2-spool control valve with pressure relief valve
- Dipstick for convertor oil
- Dipstick for hydraulic oil
- Return hydraulic filter
- Convertor oil filter
- Lift Circuit cut-off valve
- Halogen head lights
- Rear combination lights
- Rear view mirrors
- Back-up lamp
- Electric horn
- Neutral safety switch(Tor-Con)
- Deluxe rubber floor mat
- Headguard canvas
- Overhead air intake
- Radiator reservoir
- Tilt adjustable steering post
- Turn signal lights
- Lamp guard
- Full hydrostatic power steering
- Hourmeter
- Water temperature meter
- Fuel meter
- Engine oil pressure warning indicator
- Charge indicator
- Engine auto glow system(c)
- Engine after glow system(c)
- Ignition key engine stop(c)
- hand grip
- Operator tool kit
- Back-up buzzer

OPTIONAL LOADING ATTACHMENTS

- Wide view 2-stage full free KZM masts
- Wide view 3-stage full free KZSH masts
- Wide carriage
- Long forks
- Fork extension sleeves
- Side shift
- Hinged forks, bucket
- Paper roll clamp
- Carton clamp
- Rotating forks
- Multiple drums clamp
- Load push pull
- Crane arm
- Ram
- Hook

DESCRIPTION FOR THE MODEL OF FORKLIFT

- CPC - Diesel clutch type forklift
- CPCD - Diesel torque type forklift
- CPQ - Gasoline clutch type forklift
- CPQD - Gasoline torque converter type forklift
- H - Hi-power

OPTIONAL EQUIPMENT AND ACCESSORIES

- Front dual wheels and fender extension
- Solid tires
- All weather steel cabin
- Heater for steel cabin
- Color tire(white, green)
- Power clutch
- Dual air filter
- Torque convertor oil temperature meter
- Suspension seat
- Smoke reduction/spark arrester muffler(c)
- Overhead exhaust
- Fire extinguisher
- Tilt cylinder boots
- Steering cylinder boot
- LPG exclusive or dual fuel package
- Rear working light
- Custom coloring paint
- Auxiliary hydraulic valve modules
- Rear view mirrors
- Steel mesh for protection
- LPG tilt seat
- Three-way catalytic muffler

Note:

HELI will not assume any liability for damage arising from or caused by the removal of any safety devices from any of its products

Note:

HELI industrial trucks are equipped with certain safety devices as standard equipment



CE Certification



ISO9001 Certification



WIDE VIEW MAST M

Mast model	Max. fork height mm	Capacity at 500mm; Load center (kg)			Overall Mast Height at Lowered		Tilting Angle	Service Weight(kg)		
		CPQ20/CPQD20 CPC20/CPCD20	CPQ25/CPQD25 CPC25/CPCD25	CPQ30/CPQD30 CPC30/CPCD30	2-2.5t mm	3t mm		Fwd/Bwd deg	CPQ20/CPQD20 CPC20/CPCD20	CPQ25/CPQD25 CPC25/CPCD25
M200	2000	2000	2500	3000	1495	1570	6-12	3240	3600	4265
M250	2500	2000	2500	3000	1745	1820	6-12	3280	3640	4310
M270	2700	2000	2500	3000	1845	1920	6-12	3295	3655	4325
M300	3000	2000	2500	3000	1995	2070	6-12	3320	3680	4355
M330	3300	2000	2500	3000	2145	2220	6-12	3345	3705	4375
M350	3500	2000	2500	3000	2245	2320	6-12	3360	3720	4390
M370	3700	2000	2500	3000	2345	2420	6-6 *6-12	3375	3735	4410
M400	4000	2000	2500	3000	2545	2620	6-6 *6-12	3420	3780	4470
M425	4250	1900 *2000	2100 *2500	2850 *3000	2670	2745	6-6 *6-12	3440	3800	4490
M450	4500	1800 *1900	1800 *2400	2600 *3000	2795	2870	6-6 *6-12	3460	3820	4510
M475	4750	1450 *1800	1450 *2300	2400 *2900	2920	2995	6-6 *6-6	3480	3840	4530
M500	5000	1300 *1700	1300 *2200	2100 *2850	3045	3120	6-6 *6-6	3500	3860	4560
M550	5500	*1500	*1700	*2400	3345	3420	*3-6	3695	4055	4780
M600	6000	*1300	*1400	*2000	3595	3670	*3-6	3735	4095	4820

NOTE: (1) For gas, diesel model: +90kg, dual wheels weight: +110kg
(2)* (Front wheel) is dual wheels load capacity

WIDE VIEW FULL FREE 2-STAGE MAST ZM







Mast model	Max. fork height mm	Capacity at 500mm; Load center (kg)			Overall Mast Height at Lowered		Free Lift Without Backrest		Tilting Angle	Service Weight(kg)		
		CPQ20/CPQD20 CPC20/CPCD20	CPQ25/CPQD25 CPC25/CPCD25	CPQ30/CPQD30 CPC30/CPCD30	2-2.5t mm	3t mm	2-2.5t mm	3t mm		Fwd/Bwd deg	CPQ20/CPQD20 CPC20/CPCD20	CPQ25/CPQD25 CPC25/CPCD25
ZM250	2500	2000	2500	3000	1495	1820	745	600	6-12	3340	3680	4360
ZM270	2700	2000	2500	3000	1745	1920	845	700	6-12	3355	3695	4375
ZM300	3000	2000	2500	3000	1845	2070	995	850	6-12	3385	3725	4390
ZM330	3300	2000	2500	3000	2145	2220	1145	1000	6-12	3405	3750	4415
ZM350	3500	2000	2500	3000	2245	2320	1245	1100	6-12	3420	3765	4460
ZM375	3750	2000	2500	3000	2370	2445	1370	1225	6-6 *6-12	3440	3780	4480
ZM400	4000	2000	2500	3000	2545	2620	1545	1400	6-6 *6-12	3500	3840	4545
ZM425	4250	1900 *2000	2100 *2500	2850 *3000	2670	2745	1670	1525	6-6 *6-12	3525	3865	4565
ZM450	4500	1800 *1900	1800 *2400	2600 *3000	2795	2870	1795	1650	6-6 *6-12	3545	3880	4595
ZM475	4750	1450 *1800	1450 *2300	2400 *2900	2920	2995	1920	1795	6-6 *6-6	3570	3905	4600
ZM500	5000	1300 *1700	1300 *2200	2100 *2850	3045	3120	2045	1920	6-6 *6-6	3590	3925	4615

NOTE: (1) 2-2.5t free lift height (without backrest): +435mm
(2) Dual wheels weight: +110kg
(3) *(front wheel) is dual wheels load capacity

WIDE VIEW FULL FREE 3-STAGE MAST ZSM

Mast model	Max. fork height mm	Capacity at 500mm; Load center (kg)			Overall Mast Height At Lowered		Free Lift Without Backrest		Tilting Angle	Service Weight(kg)		
		CPQ20/CPQD20 CPC20/CPCD20	CPQ25/CPQD25 CPC25/CPCD25	CPQ30/CPQD30 CPC30/CPCD30	2-2.5t mm	3t mm	2-2.5t mm	3t mm		Fwd/Bwd deg	CPQ20/CPQD20 CPC20/CPCD20	CPQ25/CPQD25 CPC25/CPCD25
ZSM360	3600	1900	2400	2900	1795	1946	755	670	6-6 *6-6	3470	3810	4580
ZSM400	4000	1900	2400	2900	1920	2065	880	795	6-6 *6-6	3505	3845	4615
ZSM435	4350	1850 *1900	2200 *2400	2800 *2900	2045	2190	1005	920	6-6 *6-6	3535	3885	4650
ZSM450	4500	1700 *1800	1700 *2300	2450 *2800	2095	2240	1050	970	6-6 *6-6	3565	3910	4660
ZSM470	4700	1700 *1800	1700 *2300	2450 *2800	2160	2240	1120	970	6-6 *6-6	3565	3910	4660
ZSM480	4800	1700 *1800	1700 *2300	2450 *2800	2195	2340	1155	1070	6-6 *6-6	3575	3915	4680
ZSM500	5000	1500 *1750	1500 *2250	2300 *2750	2295	2440	1255	1170	6-6 *6-6	3715	4055	4725
ZSM540	5400	1200 *1700	1200 *2150	1700 *2650	2420	2565	1380	1295	3-6 *3-6	3895	4235	4760
ZSM600	6000	800 *1600	800 *1800	1200 *2100	2645	2790	1605	1520	3-6 *3-6	3945	4285	4850

NOTE: (1) 2-2.5t free lift height (without backrest): +435mm
(2) Dual wheels weight: +110kg
(3) *(front wheel) is dual wheels load capacity

-  **HELI** &  trade mark rights belongs to **ANHUI FORKLIFT TRUCK GROUP**
-  Unauthorized users of the Trade Mark will be prosecuted
-  For products quality and information, please contact sales service centre authorized by **HELI**
-  **ANHUI FORKLIFT TRUCK GROUP**: ISO9001  certification

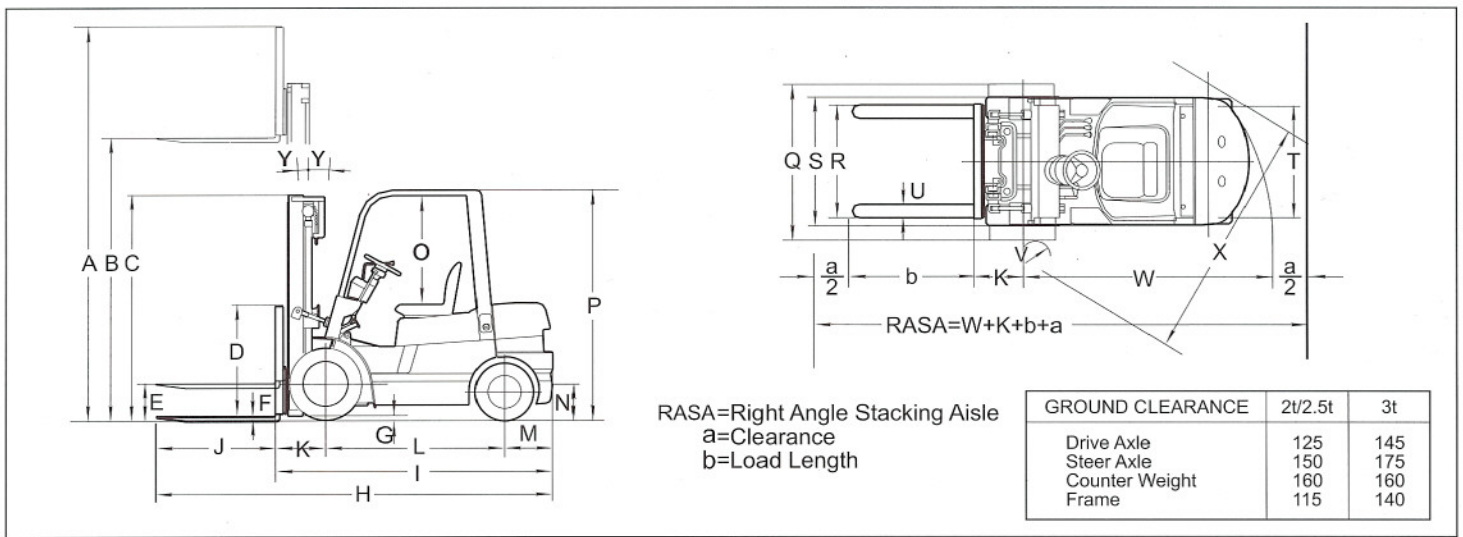

STANDARD DIMENSIONS (Front Single Tire)

Model	CPC20/CPCD20/CPQ20/CPQD20	CPC25/CPCD25/CPQ25/CPQD25	CPC30/CPCD30/CPQ30/CPQD30
	mm	mm	mm
A Overall height fork raised(with backrest)	4030	4030	4250
B Max. fork height	3000	3000	3000
C Overall height fork lowered(upright)	1995	1995	2070
D Backrest height(from upper face of forks)	1000	1000	1220
E Free lift	325	325	305
F Fork thickness	40	40	45
G Min. under-clearance(bottom of mast)	110	110	135
H Overall length(with forks)	3583	3653	3768
I Overall length(without forks)	2513	2583	2698
J Fork length	1070	1070	1070
K Fork overhang	483	483	498
L Wheel base	1600	1600	1700
M Rear overhang	430	500	500
N Coupler height	290	290	310
O Overhead guard clearance(from face of seat)	1035	1035	1035
P Overall height(overhead guard)	2070	2070	2090
Q Overall width	1150	1150	1225
R Lateral fork adjustment(Outside of fork)	245-1020	245-1020	250-1090
S Tread(front)	970	970	1000
T Tread(rear)	970	970	970
U Fork width	122	122	125
V Inside turning	160	160	200
W Outside turning radius	2170	2240	2400
X Min. intersecting aisle	1920	2010	2110
Y Tilting angles(forward-backward)	6° - 12°	6° - 12°	6° - 12°

DUAL DRIVE TIRE DIMENSIONS

Model	CPC20/CPCD20/CPQ20/CPQD20	CPC25/CPCD25/CPQ25/CPQD25	CPC30/CPCD30/CPQ30/CPQD30
	7.00-12-12PR	7.00-12-12PR	28*9-15-12PR
	mm	mm	mm
Q Overall width	1590	1590	1750
S Tread (front)	1190	1190	1260
V Inside turning radius	100	100	100
W Outside turning radius	2280	2350	2500
X Min. intersecting aisle	2120	2190	2290

HELI products and specifications are subject to improvement and change without notice.

HELI

MANUFACTURER: ANHUI HELI CO., LTD.
DISTRIBUTOR: ANHUI HELI MACHINERY IMP.& EXP.CO.,LTD.

SOLD BY:

TEL: (0086) 551-3639468, 3632133, 3648005

FAX: (0086) 551-3639966

P.C: 230022

Add: 15,Wangjiang West Road, Hefei, China

mail: heli_ick@heliforklift.com

Web site: <http://www.helimach.com>